

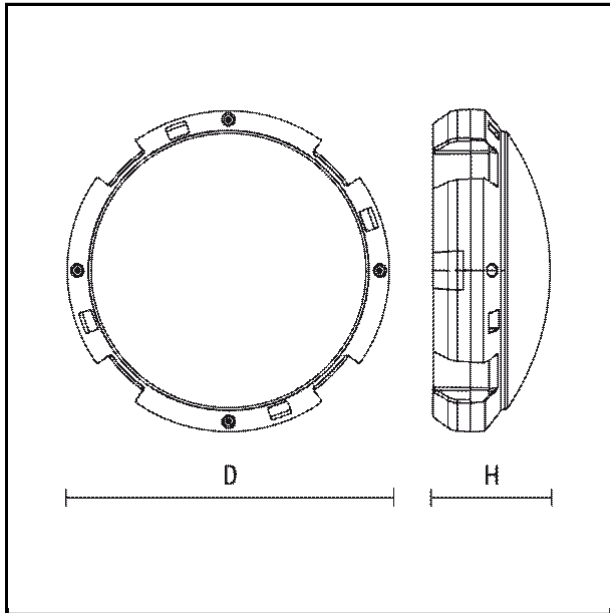





## Jack corpo tondo



<b>COD.</b>	<b>2201</b>
LAMPADA	 <b>20</b> E27
W	75W/20W
V	250V
IP	<b>IP 65</b> 
CLASSE	 <b>Classe II</b>
IK	IK08 (6 joules)
CERTIFICAZIONE	
CONFORMITÀ	EN 60 598-1:08+A11:09
COLORI	
CLASSE ENERGETICA	

### SPECIFICHE

- Struttura in policarbonato nero
- Completo di base, cablaggio, vetro e cornice
- Coppa in vetro satinato
- Ingresso cavi dal retro o laterale mediante passacavo o giunto tubo/scatola
- Alimentazione passante consentita
- Viti inox
- Lampade a basso consumo:



### DIMENSIONI

D 274 mm  
H 108,5 mm

Stampa creata il 04/12/2015 10:08

**GOCCIA ILLUMINAZIONE s.r.l.**

via E.Fermi, 59/65 | 25020 Poncarale (BS) Italy  
Tel. +39.030.26.40.761 r.a. | Fax +39.030.26.40.271  
www.goccia.it | info@goccia.it